



PORSCHE



The Panamera Turbo S

Focused Power



The Panamera Turbo S	6
Performance	14
Drive	16
Chassis	22
Balance	26
Safety	28
Lighting systems	30
Assistance systems	32
Personality	36
Personalisation	36
Colours	42
Porsche Exclusive	48
Porsche Car Configurator	49
Summary	50
Technical data	52

Turbo – a word which, when used on a Porsche, has always stood not only for technology, but also guaranteed performance and comfort that surpasses conventional limits.

S – a letter which, when used on a Porsche, has always stood for extra power and sportiness.

Once again we have combined the two – and pushed the saloon car with the heart of a sports car to its absolute limit.

The Panamera Turbo S.
Focused Power.



Force is more than a physical quantity.

Force is defined as mass times acceleration. But it's much more than that. It means powering on when others would simply pull over. It means giving everything you've got to push the limits of feasibility.

That's what the Panamera Turbo S manages to do. With 419 kW (570 hp), it achieves 37 kW (50 hp) more than the Panamera Turbo. Thanks to the standard Sport Chrono Package with overboost function, its maximum torque is 800 Nm,

whilst it sprints from 0 to 200 km/h in just 12.8 seconds, and from 0 to 100 km/h in 3.8 seconds, and achieves a top speed of 310 km/h.

Yet this enhanced performance is also accompanied by improved efficiency: despite its increased power output, the Panamera Turbo S achieves the same fuel economy in the New European Driving Cycle (NEDC) as the Panamera Turbo.

And it's not only in terms of engine power that we are reinvigorating the fascination of the sports car. In order to push its driving dynamics, stability and safety to their absolute limits, we have equipped the standard specification of the Panamera Turbo S with everything it needs to live up to the S in its name: active all-wheel drive Porsche Traction Management (PTM), Porsche Dynamic Chassis Control (PDCC) including Porsche Torque Vectoring Plus (PTV Plus), air suspension including Porsche Active Suspension Management (PASM), Power steering Plus, Porsche Ceramic Composite Brake (PCCB) and LED main

headlights including Porsche Dynamic Light System (PDLS).

The lines of the Panamera Turbo S resemble those of the Panamera Turbo. References to the top model in the range are provided by the yellow brake calipers of the PCCB, as well as the logo on the rear, and the rear spoiler with paint finish in the exterior colour. To lend the vehicle a particularly powerful appearance, the 20-inch 911 Turbo II wheels on its rear axle are also fitted with 5 mm wheel spacers. Wheel centres featuring the full-colour Porsche Crest round off the look.

For fuel consumption, CO₂ emissions and efficiency class, please refer to page 52.





Interior in two-tone combination (Agate Grey and Cream), dark walnut interior package



Headrests embossed with the Porsche Crest



Door sill guard with 'turbo S' logo

The interior of the Panamera Turbo S radiates an exclusive sporty atmosphere – whilst providing a generous amount of comfort.

Thanks to Porsche Entry & Drive, integrated as standard, you can access the vehicle and start the engine without actively using the vehicle key. The leather interior package in smooth-finish leather is standard, as are the 14-way fully electric front power seats including comfort memory package, the Porsche Crest embossed on the front headrests and seat heating for all four seats. The roof lining is in Alcantara.

The dark walnut interior package emphasises the sporty elegance of the Panamera Turbo S, whilst the BOSE® Surround Sound System, with a total output of 585 watts, provides a further sound experience – in addition to that of the engine. Porsche Communication Management (PCM) takes control of navigation, whilst front and rear ParkAssist enable easy manoeuvring. There is a choice of two steering wheels: the multifunction steering wheel or the SportDesign steering wheel with light-alloy gearshift paddles.

The 'turbo S' logos on the brushed aluminium door sills and in the rev counter are unique to this model.





Performance.



4.8-litre twin turbo V8 engine

The body's most important muscle is the heart.

Drive.

Maximum performance is never an empty phrase at Porsche. An example of this is the powerful heart of the Panamera Turbo S: the 4.8-litre twin turbo V8 engine.

Of lightweight construction, it is based on the engine of the Panamera Turbo. Due to its increased performance, it uses a reinforced crank drive and special alloy forged pistons. Stronger piston spray nozzles provide increased cooling for the piston heads. The maximum injection pressure of the

direct fuel injection (DFI) has been increased by 20 bar to 140 bar, for even better mixture control, whilst the throttle response has been optimised for a more spontaneous engine response. The integrated dry sump lubrication ensures a reliable supply of oil even when driving in a very sporty style.

The two turbochargers arranged in parallel connection have a larger, more powerful compressor in the Panamera Turbo S. Two intercoolers right and left in the front apron moulding – one for each cylinder

bank and turbocharger – are responsible for cooling the air compressed by the chargers.

As a result, the engine of the Panamera Turbo S achieves 419 kW (570 hp) at 6,000 rpm. The torque of 750 Nm starts at between 2,500 and 5,000 rpm. Whenever you accelerate at full throttle in SPORT PLUS mode, boost pressure is temporarily increased by up to 10%, thanks to the overboost function. This significantly increases the maximum torque to up to 800 Nm. Power which the

Panamera Turbo S uses to sprint from 0 to 100 km/h in 3.8 seconds and from 0 to 200 km/h in 12.8 seconds. Its maximum speed is 310 km/h. These are fascinating figures – not just for a saloon car.

A sports exhaust system featuring round dual-tube tailpipes in stainless steel is available as an option. You can select even more sporty sounds via a button on the centre console or by activating SPORT PLUS mode.

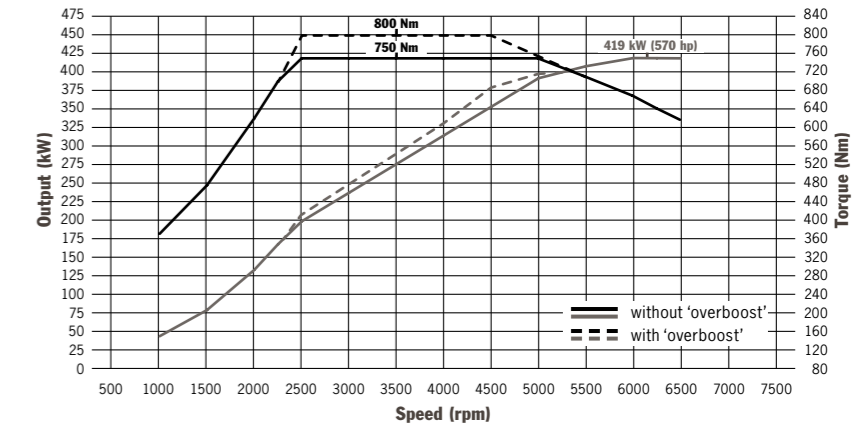

Panamera Turbo S: 419 kW (570 hp) at 6,000 rpm, 750 Nm between 2,500 and 5,000 rpm (800 Nm with 'overboost')



Sports exhaust system

For fuel consumption, CO₂ emissions and efficiency class, please refer to page 52.

Porsche Doppelkupplung (PDK).

Power transmission takes place via the 7-speed PDK with both a manual gearshift and automatic mode. It promises to deliver sports performance with efficiency and comfort, as well as rapid gear changes with no discernible interruption in the flow of power.

For the Panamera Turbo models, the PDK is particularly sporty. Depending on the gearshift programme (Normal, SPORT or SPORT PLUS button), the gear changes are optimised for comfort or very sporty driving. In SPORT PLUS mode, the PDK

is therefore designed for maximum performance: gear changes are extremely quick and maximum use is made of the driving force for optimum acceleration. At low deceleration – even at high speeds – it quickly reverts to a more dynamic braking downshift in automatic mode. In manual mode, the shift sequence has been optimised for even faster response times.

An additional function in SPORT PLUS mode is Launch Control, which enables optimum acceleration from a standing start.

Coasting.

Where the situation allows, you can use the coasting function to improve efficiency, for example on a downward slope or if you want to reduce your speed when approaching a speed limit. The PDK decouples the engine from the drivetrain to prevent the deceleration caused by engine braking. Optimum use is made of the vehicle's momentum, allowing it to coast for longer distances.

Auto start/stop function.

The auto start/stop function will not only automatically stop the engine when you come to a halt and activate the brakes, but also when you approach traffic lights, for example. This fuel-saving system restarts the engine the moment you release the brakes. The auto start/stop function can be activated and deactivated using a separate button.

For fuel consumption, CO₂ emissions and efficiency class, please refer to page 52.



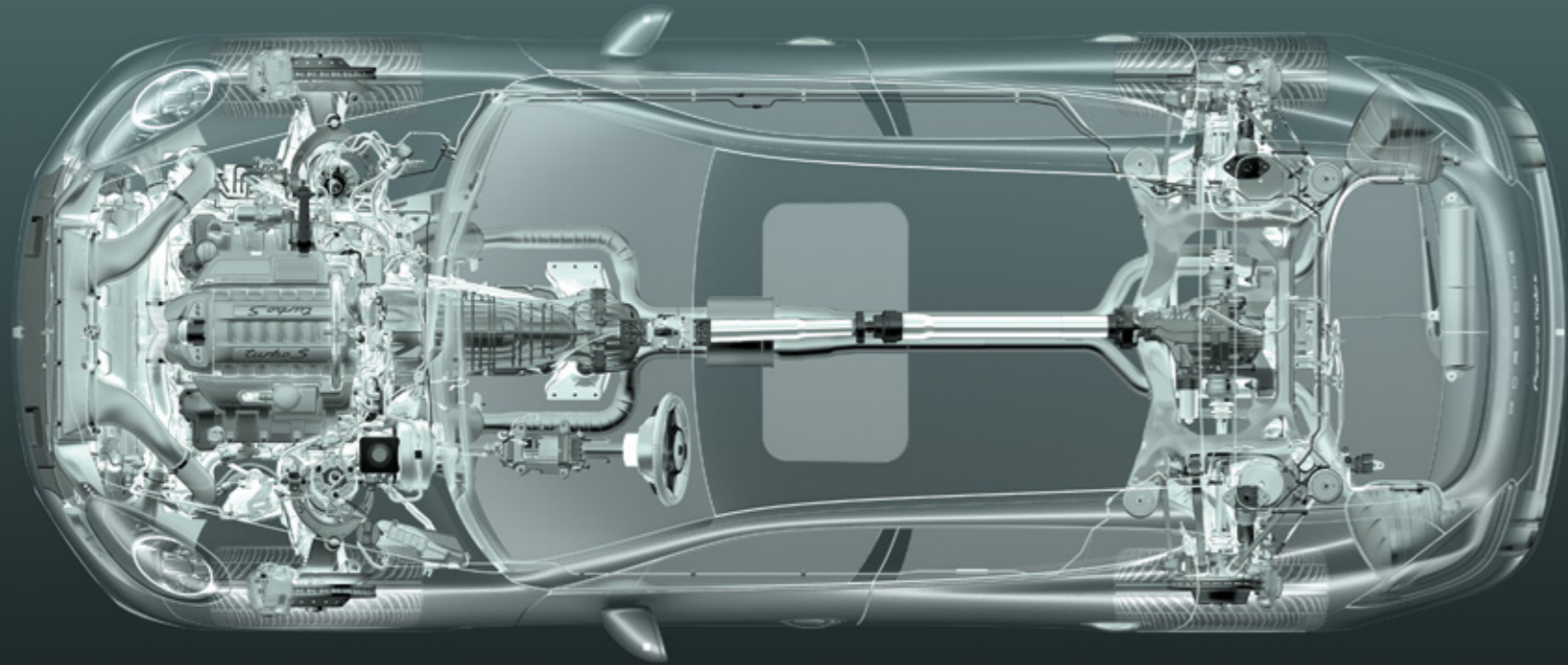

Active all-wheel drive

Porsche Traction Management (PTM).

Porsche Traction Management (PTM), which comes as standard on the Panamera Turbo S, comprises active all-wheel drive with electronically and map-controlled multi-plate clutch, automatic brake differential (ABD) and anti-slip regulation (ASR).

The electronically controlled multi-plate clutch regulates the distribution of drive force between the permanently driven rear axle and the front axle. By continuously monitoring the driving conditions, the electronics are able to respond to a variety

of situations. Among other variables, sensors continually check the rotation speeds of all four wheels, the longitudinal and lateral acceleration of the vehicle, and the steering angle.

In this way, PTM, in conjunction with Porsche Stability Management (PSM), ensures optimum force delivery in every driving situation and excellent acceleration power: whether on long straights, through tight corners, or on road surfaces with varying grip.

Porsche Stability Management (PSM).

PSM maintains stability even at the limits of dynamic driving performance. Sensors continuously monitor the direction, speed, yaw velocity and lateral acceleration of the car. PSM therefore improves traction under acceleration on inconsistent road surfaces. When SPORT PLUS mode is selected on the Sport Chrono Package, the PSM intervention threshold is raised, thereby affording you greater freedom for sporty driving.

**Power can always be directed.
You decide where.**

Chassis.

Porsche Active Suspension Management (PASM).

Included as standard equipment, Porsche Active Suspension Management (PASM) is an electronic active damping system. It offers continuous adjustment of the damping force on each wheel, based on the current driving situation and your driving style. At the press of a button, you can select between two modes: one that offers a blend of performance and comfort or one with a sportier, firmer setup.

Porsche Dynamic Chassis Control (PDCC) including Porsche Torque Vectoring Plus (PTV Plus).

Porsche Dynamic Chassis Control (PDCC), which comes as standard on the Panamera Turbo S, is an active anti-roll system which anticipates and reduces lateral body movement during cornering manoeuvres. In addition, it minimises the lateral instability of the vehicle on uneven ground.

PTV Plus enhances driving dynamics as well as stability. As a function of steering angle and steering speed, accelerator pedal position, yaw rate and vehicle speed, it is able to improve steering

response and precision by the specific braking of the right or left rear wheel.

What do PDCC and PTV Plus mean for you? Remarkable lateral stability and easier handling, excellent traction and great agility at every speed, with precise steering and stable load transfer characteristics. And even more fun when cornering.

Power steering Plus.

Power steering Plus comes as standard on the Panamera Turbo S. At high speeds, the firmer steering ratio enables precision steering manoeuvres; at low speeds, the ratio automatically adjusts to facilitate parking.

Adaptive air suspension.

The standard adaptive air suspension enhances both driving dynamics and comfort. It comprises a levelling system, manual lift function, ride-height adjustment capability and the ability to vary the spring rate. The purpose of the levelling system is to automatically keep the vehicle level constant, regardless of load distribution. For manoeuvring, the manual lift function enables you to raise the vehicle body by 20 mm to avoid the risk of grounding. When you select the SPORT PLUS chassis programme, the ride height drops to Low Level (~25 mm). At the same time, a harder spring rate is achieved by a reduction in the amount of air stored in the air suspension. In simple terms, it's a sports chassis at the push of a button.





Digital and analogue stopwatch on the dashboard

SPORT button.

The SPORT button enables you to select a setup for your Panamera Turbo S that favours either comfort or sporty performance. At the push of a button, the engine dynamics become more direct. With the PDK in automatic mode, upshifts take place at higher engine speeds and downshifts are swifter. In addition, Porsche Active Suspension Management (PASM) and Porsche Dynamic Chassis Control (PDCC) also switch to SPORT mode to deliver harder damping and more direct steering and therefore even more agile cornering.

Sport Chrono Package.

The standard Sport Chrono Package helps to provide an even sportier setup for your Panamera Turbo S. Included in the package are an analogue and digital stopwatch, longitudinal and lateral acceleration display and lap time performance display in PCM.

The SPORT PLUS button on the centre console is used to activate SPORT PLUS mode. The engine becomes even more responsive and the rev-limiter is adjusted to a harder setting. In SPORT PLUS mode, the PDK is designed for maximum

performance and extremely short shift times. Porsche Active Suspension Management (PASM) switches to SPORT PLUS mode for harder damping and more direct steering. The adaptive air suspension drops to Low Level and switches to a harder spring rate. In SPORT PLUS mode, the PSM trigger threshold is raised for increased longitudinal and lateral dynamics.

The stopwatch mounted on the dashboard displays the recorded driving time, and can also be used as a conventional clock. The special performance display in PCM allows

you to view, store and evaluate lap times or other driving times.

Additional functions of the Sport Chrono Package are: Launch Control, designed to produce optimum acceleration from a standing start, and the overboost function. Whenever you accelerate at full throttle in SPORT or SPORT PLUS mode, boost pressure will be temporarily increased by up to 10%. This considerably increases the maximum torque available from the engine, i.e. up to 800 Nm instead of 750 Nm.

For fuel consumption, CO₂ emissions and efficiency class, please refer to page 52.



Balance.

Power must always be offset.

Safety.

Porsche Ceramic Composite Brake (PCCB).

Remaining composed when faced with enormous power. That's exactly why we offset the engine's high performance with an equal amount of braking performance: a braking system which has proved itself on the racetrack, Porsche Ceramic Composite Brake (PCCB), with aluminium monobloc calipers painted in yellow. The cross-drilled ceramic brake discs have a diameter of 420 mm at the front and 350 mm at the rear. The key advantage of the PCCB is the extremely low weight of the brake discs. Approximately 50% lighter than standard discs, they significantly reduce the unsprung and rotating masses, improve roadholding,

and also increase driving comfort. Under heavy use, the low thermal expansion prevents deformations. Furthermore, the ceramic brake discs are totally resistant to corrosion and offer better noise-damping properties.

Airbags and seat belt system.

Full-size driver and front passenger airbags are standard. Depending on the severity and type of accident, they are inflated in two stages. In less serious accidents, the airbags are only partially inflated, thereby minimising discomfort to the occupants. As well as knee airbags for the driver and front passenger, the Porsche Side Impact Protection System (POSIP) is also fitted

as standard. This comprises side airbags in the front seats, curtain airbags along the entire roof frame and side windows from the A-pillar to the C-pillar, and side impact protection elements in the doors.

Side airbags in the rear compartment are available as an option.



Porsche Ceramic Composite Brake (PCCB)





Night light design of the LED main headlights



Daytime running lights of the LED main headlights

Sometimes, looking ahead also means thinking outside the box.

Lighting systems.

LED main headlights including Porsche Dynamic Light System (PDLS).

The Panamera Turbo S comes with LED main headlights including Porsche Dynamic Light System (PDLS) as standard. The headlights comprise two, stepped light units. The four-spot daytime running lights encircled by a light ring are integrated into the headlights. A design feature that certainly leaves an impression.

The LED beam is remarkably powerful and provides excellent illumination of the road. Thanks to the optimised balance between short and long distance lighting

with side illumination and the similarity in colour to daylight, the driver's eyes tire less quickly than with other systems.

The Porsche Dynamic Light System (PDLS) has been combined with the LED main headlights. The dynamic cornering light function swivels the headlights towards the inside of the bend, based on the steering angle and driving speed. The static cornering lights activate the auxiliary headlights in order to illuminate more of the road at tight bends and turns. PDLS also adapts beam distribution in line with driving speed.

Another function is the adverse weather function. This is activated whenever the rear fog light is switched on and improves safety by reducing the dazzle to which you are exposed and by providing better illumination of the kerbside.

Porsche Dynamic Light System Plus (PDLS+).

Available on request for your Panamera Turbo S: Porsche Dynamic Light System Plus (PDLS+). Not only does PDLS+ offer all the functions of PDLS, it also features a dynamic main beam and an intersection assistant function.

The dynamic main beam is activated from a speed of 65 km/h and detects vehicles driving in front as well as oncoming traffic. The intensity and range of the light cone can therefore be adapted to the prevailing conditions.

With the intersection assistant function, intersections and T-junctions are recognised based on the navigation data from the PCM. For optimum illumination of intersections, the system automatically switches on the left and right cornering lights. At a T-junction, only the static cornering light on the same side as the emerging traffic is switched on.

Care, patience, prudence.
Your Panamera also uses the ‘check twice’ principle.

Assistance systems.

Reversing camera and Surround View.

The optional reversing camera facilitates precise reverse parking by displaying a camera image and dynamic, superimposed guidelines on the PCM screen. The Surround View system supplements the reversing camera with three more cameras – one in the front apron and one in each exterior mirror. Based on the information they provide, the system generates a virtual bird’s eye view and displays it on the PCM screen, meaning that even lower obstacles to the front and side of the vehicle can be detected when parking.

Adaptive cruise control including Porsche Active Safe (PAS).

Automatic cruise control is standard, with the enhanced, adaptive version available as an option. Using a radar sensor inside the front apron, it regulates the speed of your vehicle in line with that of the vehicle in front. If you start to drive too close, it gently applies the brakes, bringing your vehicle to a stop if necessary. Safety is further improved by Porsche Active Safe (PAS) integrated in the adaptive cruise control. If you are approaching the vehicle in front too quickly, you will

be prompted to take the necessary action by an audible and visual warning as well as a jolt of the brakes. The system may also intervene with targeted braking applications and act to boost brake pressure as the situation demands, even to the point of the maximum braking force that the system is able to provide.

Lane Departure Warning.

With optional Lane Departure Warning, a camera inside the rear-view mirror monitors the road surface in front of the vehicle. When activated, the system will sound a

warning tone whenever you steer towards a divider line marking and threaten to leave the current lane without indicating.

Speed limit indicator.

The speed limit indicator is available as an option. A camera identifies traffic signs such as the start and end of speed limits and ‘no overtaking’ zones. The speed limit or overtaking restriction is displayed via the instrument cluster and PCM.



Speed limit indicator



Adaptive cruise control with Lane Departure Warning



Porsche Car Connect.

Short, direct routes – this has been a Porsche principle since the very beginning. And it's the same in the digital age. Porsche Car Connect is the gateway between your Panamera Turbo S and the possibilities of the 21st century, strengthening the bond between your vehicle and you. Porsche Car Connect is a smartphone app that enables you to access various data relating to your car and control certain functions remotely.

Carfinder displays the shortest route from your current position to your car's parked location.

Thanks to Remote Vehicle Status, the most important data from your Panamera Turbo S is always available at a glance. For example, you can call up your odometer reading and fuel level or check whether the windows and doors are open or closed.

Remote Services gives you fingertip access to a range of statistics recorded by your car, including the distance covered, average speed and fuel consumed during the last drive.

Porsche Car Connect enables you to make a breakdown call at any time and from any location.

You can also check the status of the alarm system whenever you want, wherever you are. In addition, you can use your smartphone to control the locking of doors and the folding of the exterior mirrors.

Porsche Car Connect also includes the Porsche Vehicle Tracking System (PVTs), which enables the remote location of a stolen vehicle across most of Europe.



To reach the source of power, you must swim against the current.

Personalisation.

The comprehensive standard specification of the Panamera Turbo S may be second to none, but we appreciate that you may wish to tailor your vehicle entirely to your personal preference. We present some of the options on the following pages.

The extensive colour range of the Panamera Turbo S offers no fewer than 16 exterior colours. Then there are seven interior colours and six two-tone combinations, plus eight interior packages in aluminium, carbon or a selection of woods. If you can't find the colour you'd like for your Panamera Turbo S, we can probably mix it for you.

These are just some of the many ways to style your Panamera Turbo S to your personal preference: how about having your car personalised at the factory through Porsche Exclusive, or why not consider our range of aftermarket accessories from Porsche Tequipment?

Using the Porsche Car Configurator at www.porsche.com, you can see what the available options and colours would look like on your computer-generated car, not only on the exterior, but in the interior, too.





Porsche Rear Seat Entertainment Plus

Soft close doors.

Soft close doors are available as an option. All four doors can be closed comfortably and safely thanks to a drawing mechanism integrated into the lock.

Four-zone automatic climate control.

Four-zone climate control with separate temperature controls for all four seats is available as an option. Air conditioning for the rear seating area is, of course, also possible from the rear seats – via a control panel in the rear centre console.

Adaptive Sports seats.

The optional adaptive Sports seats with comfort memory package provide even better lateral support, thanks to the raised side bolsters on the seat squab and backrest. The seats can be individually adjusted for added comfort over long distances or precision lateral support on winding roads.

Seat ventilation.

If required, we can equip all four seats with seat ventilation. A slipstream effect is produced by active ventilation of the

perforated seat centre and backrest and by passive aeration at the side bolsters, making for a comfortable seating environment, even in hot weather. Seat ventilation can be adjusted independently to any one of three power levels, and can be used in conjunction with seat heating.

Porsche Rear Seat Entertainment Plus.¹⁾

Enjoy a cinematic experience in the second row with Porsche Rear Seat Entertainment Plus. Thanks to two separate 10.1-inch touchscreens on the front seat backrests, an integrated DVD

drive, SD card slot, Bluetooth® headphones and an internal 32-GB flash memory, a world of entertainment is at your passengers' fingertips.

¹⁾ Available from 06/2015 at the earliest.

Burmester® High-End Surround Sound System.

If required, the sound of your Panamera Turbo S can be amplified by sounds from Berlin. We're referring to Burmester®, one of the world's most respected manufacturers of high-end audio equipment, and the Burmester® High-End Surround Sound System, which is available as an option in combination with the CDR audio system or PCM. The technologies behind the system are from the finest of the premium home audio systems that Burmester® has to offer.

The system owes its eminence to countless details, and one goal: perfection in sound.

The system has 16 amplifier channels with a total output of more than 1,000 watts, 16 loudspeakers including an active subwoofer with 300-watt class D amplifier, a total diaphragm surface area of more than 2,400 cm², and a frequency response of 30 Hz to 20 kHz. Crossover technology has been carried over more or less unmodified from the home audio sector. Analogue and digital

filters have been optimally defined for their installation location and finely tuned following extensive in-car audio testing. Ribbon tweeters have been used for unmistakably fine, clear and undistorted high-frequency sound reproduction with excellent level stability. All loudspeaker housings are perfectly matched and deliver superior bass foundation, definition and impulse precision. The result is an unprecedented natural and richly textured spatial sound, even at top volume. The elegantly pure design with galvanised surrounds and Burmester®

logos on selected loudspeakers make it clear that the appeal of the Burmester® High-End Surround Sound System is as much about the visual as it is the audio, offering sound and style without compromise.



Solid exterior colours.

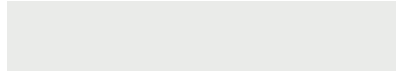

White

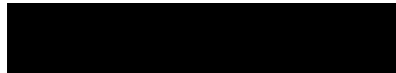

Black



Metallic exterior colours.

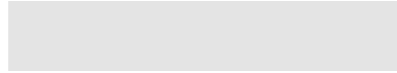

Carrara White Metallic



Rhodium Silver Metallic



Sapphire Blue Metallic



Ruby Red Metallic



Chestnut Brown Metallic



Mahogany Metallic



Night Blue Metallic



Carbon Grey Metallic



Agate Grey Metallic



Jet Black Metallic



Special exterior colours.



GT Silver Metallic



Palladium Metallic



Carmine Red



Amethyst Metallic



Standard interior colours.

**Leather/soft-touch paint.
Interior colour.**

Carpet.

**Roof lining
(Alcantara).**

**Leather/soft-touch paint.
Interior colour.**

Carpet.

**Roof lining
(Alcantara).**



Black



Black

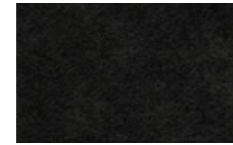

Black



Marsala



Marsala



Platinum Grey



Agate Grey



Agate Grey



Platinum Grey



Saddle Brown



Saddle Brown



Saddle Brown



Luxor Beige



Luxor Beige



Luxor Beige

Two-tone interior.

**Leather/soft-touch paint.
Interior colour.**

Carpet.

**Roof lining
(Alcantara).**

**Leather/soft-touch paint.
Interior colour.**

Carpet.

**Roof lining
(Alcantara).**



Luxor Beige and Cream



Cream*



Cream



Agate Grey and Cream



Agate Grey*



Cream



Marsala and Cream



Cream*



Cream



Black and Garnet Red



Black*



Black



Black and Cream



Black*



Cream



Black and Saddle Brown



Black*



Saddle Brown

*With two-tone packages, the luggage compartment is styled in the respective darker colour.

Natural leather interior.

**Leather/soft-touch paint.
Interior colour.**

Carpet.

**Roof lining
(Alcantara).**



Cognac



Cognac



Cedar



Espresso



Espresso



Platinum Grey

Interior packages.

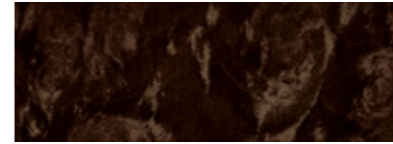

Dark walnut



Carbon



Brushed aluminium



Anthracite birch



Tineo



Black (high-gloss)



Natural olive



Yachting Mahogany



Porsche Exclusive.

A state-of-the-art vehicle tailored to your requirements.

With the range of options featured in this catalogue, you can make your Porsche even more special. Introducing Porsche Exclusive. Have your vehicle individually

and exclusively tailored to your requirements even before it leaves the factory. Aesthetically and technically, inside and outside, using fine materials and with customary Porsche quality.

Our overriding principle? That your car is uniquely handcrafted to your taste. You will find a wide range of design options in the separate Porsche Exclusive Panamera catalogue.

Either your Porsche Centre or the Customer Centre in Zuffenhausen (e-mail customercenter-exclusive@porsche.de or telephone +49 711 911-25977) will be happy to answer any questions that you may have about Porsche Exclusive.

Porsche Car Configurator.

Taste, personality and style. You decide how to refine the Panamera Turbo S to your personal preference. With the Porsche Car Configurator, you can see the result instantly on your computer. Just four steps are all it takes to create your own Porsche. It's as simple as selecting or deselecting the options you want. The price is recalculated automatically with each click. It looks stunning, because the features are rendered in 3D. So you can view your configuration from any angle, save it and print it off there and then.

Visit www.porsche.com to access the Porsche Car Configurator and experience the fascinating world of Porsche.

Porsche Panamera Turbo S 2D 3D

Standard Colour
Metallic Colour
Special Colour

Wheels
Wheel accessories
 All-season tyres for 20-inch alloy wheels

Standard features
Technical specifications
Tire Labeling

Models | **1. Exterior ✓** | 2. Interior | 3. Options | 4. Summary | Next Step >

**Power is usually created wherever
new ideas become reality.**

The Panamera Turbo S.



Engine.

Cylinders	8
Displacement	4,806 cm ³
Max. power (DIN) at rpm	419 kW (570 hp) 6,000
Max. torque at rpm	750 Nm 2,500–5,000
Max. torque with overboost at rpm	800 Nm 2,500–4,500
Compression ratio	10.5 : 1

Chassis.

Front axle	Aluminium double wishbone suspension
Rear axle	Aluminium multi-link with chassis subframe
Steering	Hydraulic power steering
Brakes	Porsche Ceramic Composite Brake (PCCB). Six-piston aluminium monobloc fixed brake calipers at front and four-piston units at rear, carbon-ceramic composite brake discs internally vented and cross-drilled
Wheels	Front: 9.5 J x 20 ET 65, Rear: 11 J x 20 ET 68
Tyres	Front: 255/40 ZR 20, Rear: 295/35 ZR 20

Performance.

Top speed	310 km/h
0–100 km/h	3.8 secs ¹⁾
0–200 km/h	12.8 secs ¹⁾
Overtaking acceleration 80–120 km/h	2.4 secs ¹⁾

Transmission.

Layout	Active all-wheel drive
PDK	7-speed

Fuel consumption/emissions²⁾/efficiency class.³⁾





Fuel grade	Super Plus unleaded (RON 98)
Urban in l/100 km	14.9
Extra urban in l/100 km	7.8
Combined in l/100 km	10.4
CO ₂ emissions in g/km	242
Efficiency class Germany/Switzerland ³⁾	F/G

Weights.



Unladen weight (DIN)	1,995 kg
Unladen weight (EC) ⁴⁾	2,070 kg
Permissible gross weight	2,500 kg
Maximum payload	505 kg

Dimensions.

Length	5,015 mm
Width (incl. exterior mirrors)	1,931 mm (2,114 mm)
Height	1,418 mm
Luggage compartment volume (German Car Manufacturers' Assoc.) with rear seats folded down	432 litres 1,250 litres
Tank capacity	100 litres

Tyre type	Size	Fuel efficiency/ rolling resistance	Wet grip class	External rolling noise* (class)	External rolling noise (dB)
Panamera					
Summer tyres	255/40 ZR 20	E–C	B–A		73–71
	295/35 ZR 20	E–C	B–A		74–73
All-season tyres	255/40 R 20	C–B	C–B		73–72
	295/35 R 20	C–B	C–B	 – 	74–72

¹⁾ For logistical and technical reasons relating to the production process, we are unable to accept orders for a particular make of tyre.

*  Quiet rolling noise,  Moderate rolling noise,  Loud rolling noise.

¹⁾ With SPORT PLUS button selected.

²⁾ Data determined in the NEDC (New European Driving Cycle) in accordance with the EURO 6 (715/2007/EC, 195/2013/EC and ECE-R 101.01) measurement method. The figures do not refer to an individual vehicle nor do they constitute part of the offer. They are intended solely as a means of comparing different types of vehicle. Fuel consumption calculated for vehicles with standard specification only. Actual consumption and performance may vary with items of optional equipment. A vehicle's fuel consumption and CO₂ emissions depend not only on its efficient use of fuel but also on driving style and other non-technical factors. The latest Porsche models with petrol engine are designed to operate on fuels with an ethanol content of up to 10 %. You can obtain further information about individual vehicles from your Porsche Centre.

³⁾ Valid in the countries listed only.

⁴⁾ Weight is calculated in accordance with the relevant EC Directives and is valid for vehicles with standard specification only. Optional equipment increases this figure. The figure given includes 68 kg for the driver and 7 kg for luggage.

The models featured in this publication are approved for road use in Germany. Some items of equipment are available as extra-cost options only. The availability of models and options may vary from market to market due to local restrictions and regulations. For information on standard and optional equipment, please consult your Porsche Centre. All information regarding construction, features, design, performance, dimensions, weight, fuel consumption and running costs is correct to the best of our knowledge at the time of going to print (12/14). Porsche reserves the right to alter specifications, equipment and delivery scopes without prior notice. Colours may differ from those illustrated. Errors and omissions excepted.

© Dr. Ing. h.c. F. Porsche AG, 2015
All text, images and other information in this publication are subject to the copyright of Dr. Ing. h.c. F. Porsche AG.

No part of this publication may be reproduced or transmitted, in any form or by any means, without prior permission in writing from Dr. Ing. h.c. F. Porsche AG.

Dr. Ing. h.c. F. Porsche AG supports the use of paper from sustainable forests. The paper for this brochure is certified in accordance with the strict regulations of the PEFC (Programme for the Endorsement of Forest Certification).

Porsche, the Porsche Crest, Panamera, 911, PCCB, PCM, PSM, PDK, Tequipment and other marks are registered trademarks of Dr. Ing. h.c. F. Porsche AG.

Dr. Ing. h.c. F. Porsche AG
Porscheplatz 1
70435 Stuttgart
Germany
www.porsche.com

Effective from: 03/15
Printed in Germany
WSLP1601000220 EN/WW

